

**ACCESSORIES**

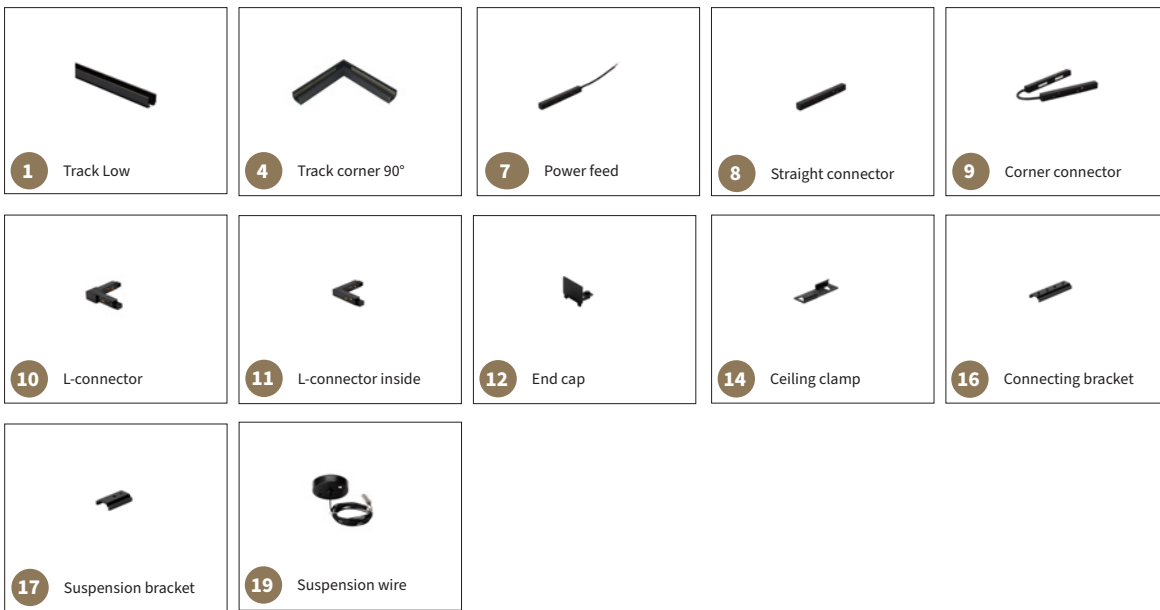

**ARTICLE NUMBER**

**DESCRIPTION**

**ACCESSORY NUMBER**

**COLOR**

5833.995.99.3	Magnet Track Low surface 3000mm White	1	White
5833.995.99.5	Magnet Track Low surface 3000mm Black	1	Black



**ARTICLE NUMBER**

**DESCRIPTION**

**ACCESSORY NUMBER**

**COLOR**

5850.995.99.3	Magnet Track corner 90° Low White	4	White
5850.995.99.5	Magnet Track corner 90° Low Black	4	Black



ARTICLE NUMBER	DESCRIPTION	ACCESSORY NUMBER	COLOR
5852.998.99.3	Magnet Power feed White incl. 3m cable	7	White
5852.998.99.5	Magnet Power feed Black incl. 3m cable	7	Black



ARTICLE NUMBER	DESCRIPTION	ACCESSORY NUMBER	COLOR
5854.998.99.3	Magnet Straight Connector White	8	White
5854.998.99.5	Magnet Straight Connector Black	8	Black



ARTICLE NUMBER	DESCRIPTION	ACCESSORY NUMBER	COLOR
5853.998.99.3	Magnet Corner Connector White	9	White
5853.998.99.5	Magnet Corner Connector Black	9	Black



ARTICLE NUMBER	DESCRIPTION	ACCESSORY NUMBER	COLOR
5851.995.99.3	Magnet L-connector Low White (Outside corner)	10	White
5851.995.99.5	Magnet L-connector Low Black (Outside corner)	10	Black



ARTICLE NUMBER	DESCRIPTION	ACCESSORY NUMBER	COLOR
5851.998.99.3	Magnet L-connector White (Inside track)	11	White
5851.998.99.5	Magnet L-connector Black (Inside track)	11	Black

**Use when you cut the track in 45 degrees**



ARTICLE NUMBER	DESCRIPTION	ACCESSORY NUMBER	COLOR
5864.995.99.3	Magnet End Cap Low White	12	White
5864.995.99.5	Magnet End Cap Low Black	12	Black



ARTICLE NUMBER	DESCRIPTION	ACCESSORY NUMBER	COLOR
5865.995.99.3	Magnet Ceiling Clamp Low White	14	White
5865.995.99.5	Magnet Ceiling Clamp Low Black	14	Black



ARTICLE NUMBER	DESCRIPTION	ACCESSORY NUMBER	COLOR
5867.995.99.3	Magnet Connecting Bracket Low White	16	White
5867.995.99.5	Magnet Connecting Bracket Low Black	16	Black









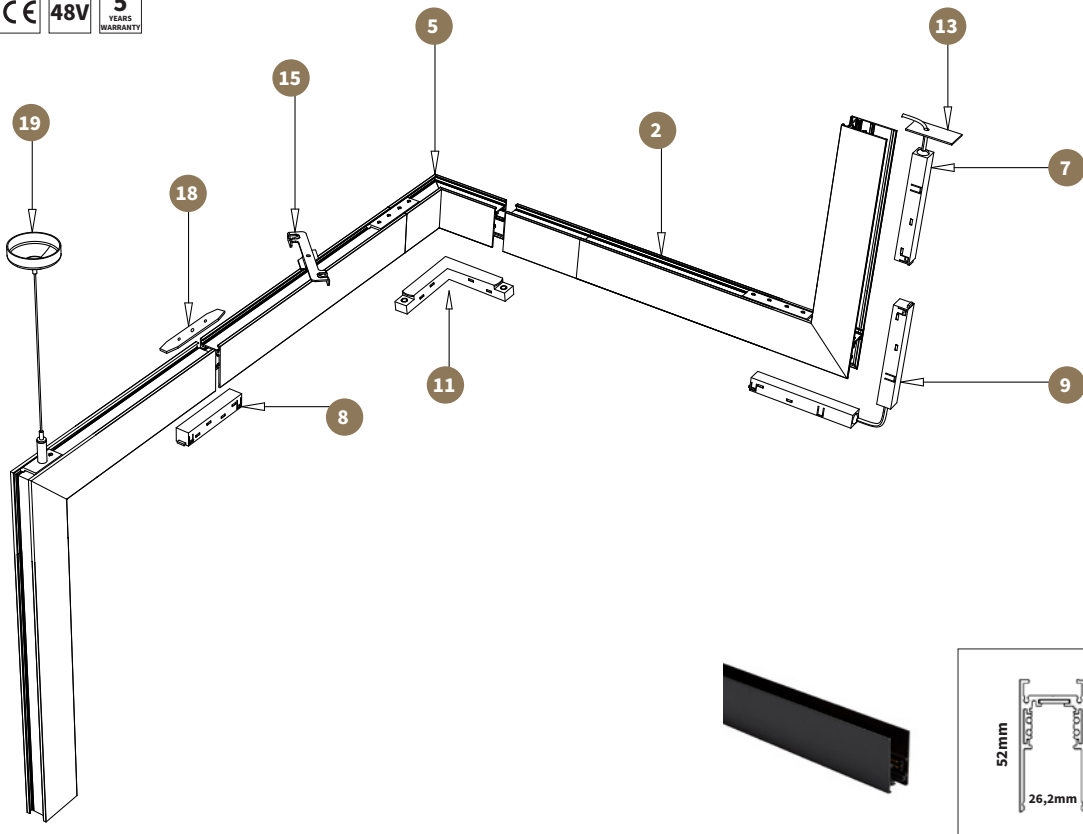



ARTICLE NUMBER	DESCRIPTION	ACCESSORY NUMBER	COLOR
5866.995.99.3	Magnet Suspension Bracket Low White	17	White
5866.995.99.5	Magnet Suspension Bracket Low Black	17	Black



ARTICLE NUMBER	DESCRIPTION	ACCESSORY NUMBER	COLOR
5888.995.99.3	Magnet Suspension Wire with quick release Clamp 3m White	19	White
5888.995.99.5	Magnet Suspension Wire with quick release Clamp 3m Black	19	Black



**ACCESSORIES**

 <b>2</b> Track High	 <b>5</b> Track corner 90°	 <b>7</b> Power feed	 <b>8</b> Straight connector	 <b>9</b> Corner connector
 <b>11</b> L-connector inside	 <b>13</b> End cap	 <b>15</b> Ceiling clamp	 <b>18</b> Suspension connecting bracket	 <b>19</b> Suspension wire



ARTICLE NUMBER	DESCRIPTION	ACCESSORY NUMBER	COLOR
5833.996.99.5	Magnet Track High surface 3000mm Black	2	Black



ARTICLE NUMBER	DESCRIPTION	LENGTH	COLOR
5850.996.99.5	Magnet Track corner 90° High Black	5	Black



ARTICLE NUMBER	DESCRIPTION	ACCESSORY NUMBER	COLOR
5852.998.99.3	Magnet Power feed White incl. 3m cable	7	White
5852.998.99.5	Magnet Power feed Black incl. 3m cable	7	Black



ARTICLE NUMBER	DESCRIPTION	ACCESSORY NUMBER	COLOR
5854.998.99.3	Magnet Straight Connector White	8	White
5854.998.99.5	Magnet Straight Connector Black	8	Black



ARTICLE NUMBER	DESCRIPTION	ACCESSORY NUMBER	COLOR
5853.998.99.3	Magnet Corner Connector White	9	White
5853.998.99.5	Magnet Corner Connector Black	9	Black



ARTICLE NUMBER	DESCRIPTION	ACCESSORY NUMBER	COLOR
5851.998.99.3	Magnet L-connector White (Inside track)	11	White
5851.998.99.5	Magnet L-connector Black (Inside track)	11	Black
<b>Use when you cut the track in 45 degrees</b>			



ARTICLE NUMBER	DESCRIPTION	ACCESSORY NUMBER	COLOR
5864.996.99.5	Magnet End Cap High/Recessed Black	13	Black



ARTICLE NUMBER	DESCRIPTION	ACCESSORY NUMBER	COLOR
5865.996.99.5	Magnet Ceiling Clamp High/Recessed Black	15	Black



ARTICLE NUMBER	DESCRIPTION	ACCESSORY NUMBER	COLOR
5890.996.99.5	Magnet suspension Connecting Bracket High/Recessed Black	18	Black



ARTICLE NUMBER	DESCRIPTION	ACCESSORY NUMBER	COLOR
5888.995.99.3	Magnet Suspension Wire with quick release Clamp 3m White	19	White
5888.995.99.5	Magnet Suspension Wire with quick release Clamp 3m Black	19	Black

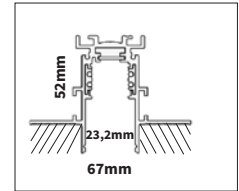
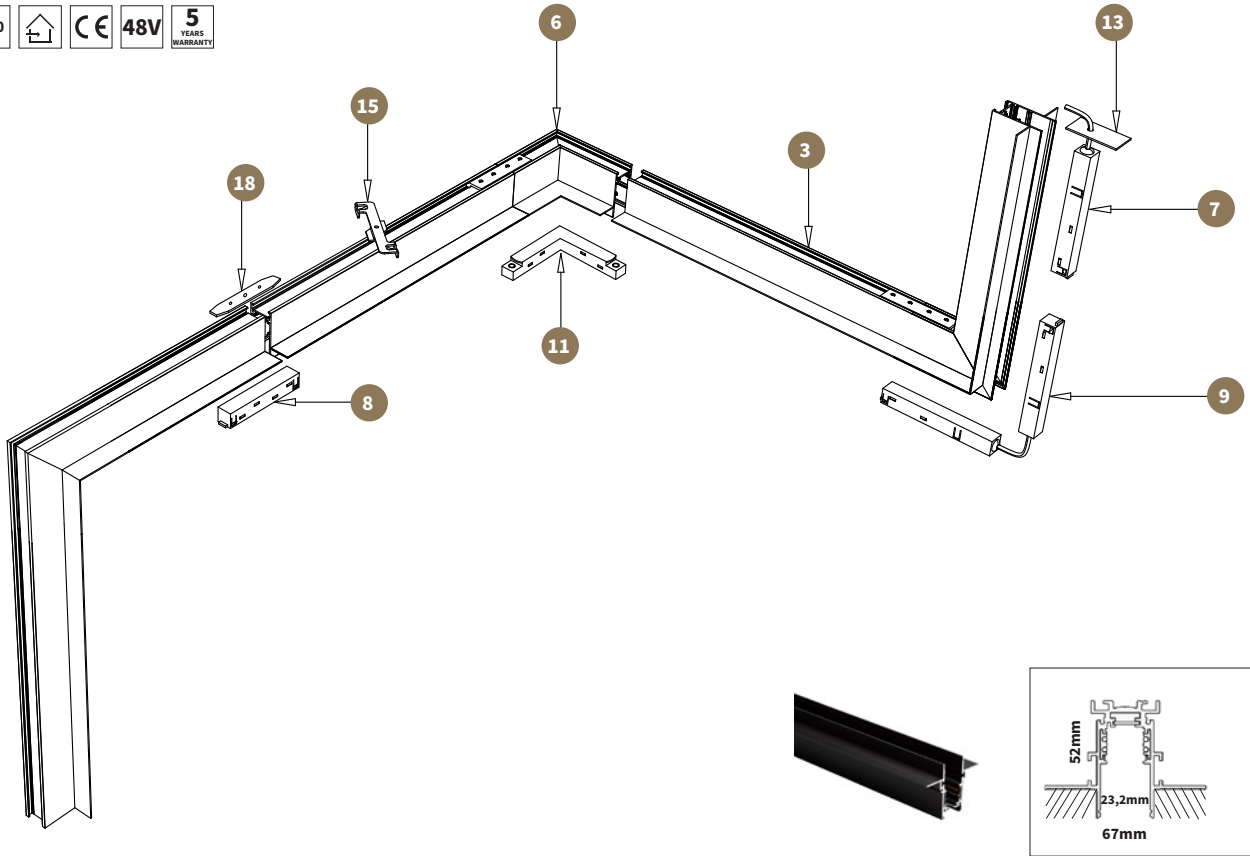

**ACCESSORIES**

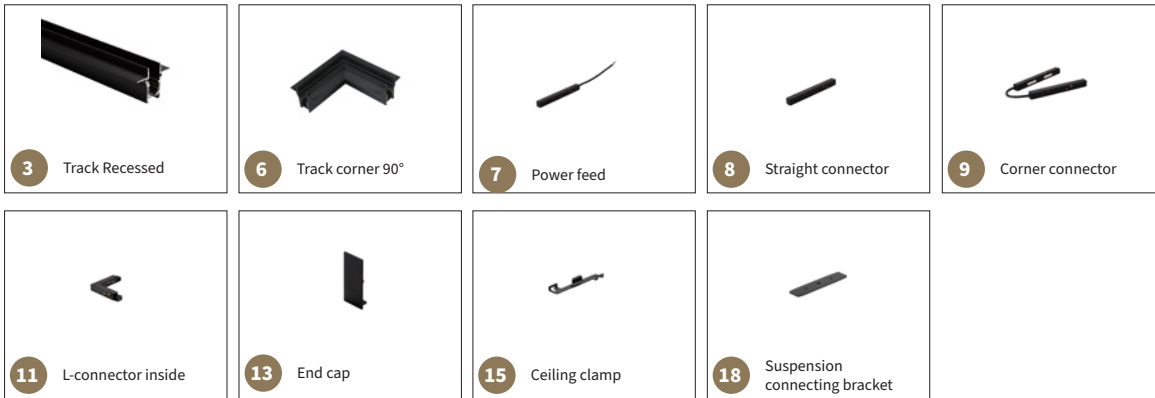



ARTICLE NUMBER	DESCRIPTION	ACCESSORY NUMBER	COLOR
5833.997.99.5	Magnet Track High recessed 3000mm Black	3	Black



ARTICLE NUMBER	DESCRIPTION	ACCESSORY NUMBER	COLOR
5850.997.99.5	Magnet Track corner 90° Recessed Black	6	Black



ARTICLE NUMBER	DESCRIPTION	ACCESSORY NUMBER	COLOR
5852.998.99.3	Magnet Power feed White incl. 3m cable	7	White
5852.998.99.5	Magnet Power feed Black incl. 3m cable	7	Black



ARTICLE NUMBER	DESCRIPTION	ACCESSORY NUMBER	COLOR
5854.998.99.3	Magnet Straight Connector White	8	White
5854.998.99.5	Magnet Straight Connector Black	8	Black



ARTICLE NUMBER	DESCRIPTION	ACCESSORY NUMBER	COLOR
5853.998.99.3	Magnet Corner Connector White	9	White
5853.998.99.5	Magnet Corner Connector Black	9	Black



ARTICLE NUMBER	DESCRIPTION	ACCESSORY NUMBER	COLOR
5851.998.99.3	Magnet L-connector White (Inside track)	11	White
5851.998.99.5	Magnet L-connector Black (Inside track)	11	Black
<b>Use when you cut the track in 45 degrees</b>			



ARTICLE NUMBER	DESCRIPTION	ACCESSORY NUMBER	COLOR
5864.996.99.5	Magnet End Cap High/Recessed Black	13	Black



ARTICLE NUMBER	DESCRIPTION	ACCESSORY NUMBER	COLOR
5865.996.99.5	Magnet Ceiling Clamp High/Recessed Black	15	Black



ARTICLE NUMBER	DESCRIPTION	ACCESSORY NUMBER	COLOR
5890.996.99.5	Magnet suspension Connecting Bracket High/Recessed Black	18	Black



ARTICLE NUMBER	VOLTAGE	WATTAGE	IP
0148.100.10.1	48VDC	100W	IP67
0148.150.10.1	48VDC	150W	IP67
0148.240.10.0	48VDC	240W	IP67
0148.320.10.0	48VDC	320W	IP67

Full warranty only applies when fixture is purchased in combination with recommended driver.